

SMART-THERM STS II® INDUCTION CHARGER



DX821 series
INDUCTION BASE

Application

The ideal Induction Charging System for room service, meal delivery, and boosting applications. Eco friendly and flameless, operates only when energized by Dinex® base; space efficient.

This equipment is intended for "Industrial Use Only".

Construction

Charger shall be manufactured in the United States and constructed with the main body of stainless steel and composite induction friendly materials. Charger shall be equipped with a microprocessor that performs unique, patented and patent pending temperature control, automatic standby/shut-off and self-diagnostics. Charger shall have an automatic sensor for use with Dinex Induction Bases. Charger shall have a digital display panel to show the portion of the charge that has been completed and visible error warnings in several languages with simple operator overrides.

We do not accept returns on any Dinex equipment or Dinex custom products. Please contact your local Dinex rep to ensure order accuracy prior to ordering.

Standard Features

- Countertop design, case made of stainless steel and composite durable induction compatible materials engineered for use in commercial kitchens.
- User-friendly control buttons for ease of use and automatic power control.
- Visible LCD display & audible alert for precise user feedback.
- Automatic standby/shut-off feature.
- Easy-to-clean composite top surface.

Smart-Therm STS II Induction Charger

- Integral cooling fan keeps internal electronics cool.
- Single unit works on all 208v, 220v, and 240v systems. Base cycle time ranges from 14 to 19 second dependent on supply voltage. **Note:** Fluctuation in voltage may affect heating cycle time.
- Space efficient 15.3" x 18.3"
- Cleanable filter
- Internal surge protector
- Multi-lingual option
 - English
 - French
 - Spanish

Item Numbers

Smart-Therm STS II Induction Charger
 DX811220

9" Bases for Induction System

- DX821003 - Onyx
- DX821008 - Hunter Green
- DX821031 - Latte
- DX821050 - Midnight Blue
- DX821061 - Cranberry
- DX821068 - Plum
- DX821084 - Sage

Drying & Storage Racks For 9" Induction Bases

- DXIBDRS90 -
Holds 90 Induction Bases
- DXIBDRS180 -
Holds 180 Induction Bases
- DXIBDRS270 -
Holds 270 Induction Bases

9" Replacement Cradle for Storage Rack

- DX10251

Smart-Therm STS II System

- Senses Dinex Induction Base automatically and gives the correct amount of energy to get correct temperature every time.
- Microprocessor monitors vital components and runs near continuous performance checks.
- Charger shuts off automatically and displays error codes in plain text enabling user to diagnose or identify minor problems.
- Uses new, durable 9" Dinex Induction Bases.

Warranty

Two years parts and labor.

DINEX
A CARLISLE COMPANY

4711 E Hefner Road
Oklahoma City, OK 73131
800.654.8210 • 405.475.5600
www.dinex.com

149-REV 05/13

SMART•THERM STS II® INDUCTION CHARGER

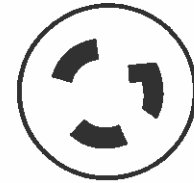
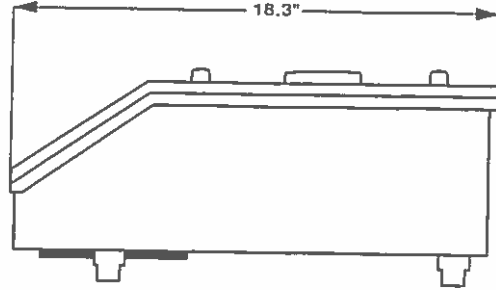
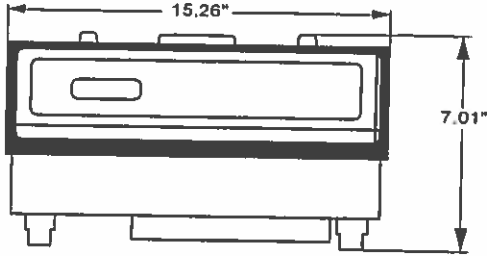

NEMA L6-20P

Specifications

Item Number	Model Number	Overall Size			Electrical Specifications			Shipping Specs	
		W	D	H	Volts	AMPS	Watt	Ship Weight	Ship Cube
DX811220	811220	15.26" (38.8cm)	18.3" (46.5cm)	7.01" (17.8cm)	208v/220v/240v 1-Phase	16	3350/3850	23 lb.	1.6

Please confirm that you have the most current specification sheet by visiting www.dinex.com.
Dinex® reserves the right to change specifications and product design without notice.
Such revisions do not entitle the buyer to corresponding changes, improvements, additions or replacements for previously purchased equipment.

Printed in USA

DINEX.
A CARLISLE COMPANY

4711 E Hefner Road
Oklahoma City, OK 73131
800.654.8210 • 405.475.5600
www.dinex.com

149-REV 05/13

ATTACHMENT A



DX1173X100 - Dinex® Drying and Storage Cart (Holds 100 Domes or 200 Bases) 40" x 20.25" x 73" - Stainless Steel



Details

Item #	Case Pack
DX1173X100	1 cs
Product #	Each UPC
DX1173X100	753806050037
Color	Case UPC
Stainless Steel	753806050037



Invoice Description
DRYING/STORAGE CART (100)



Features

- Keep your trayline and dishwashing area organized and operating at peak efficiency
- The stainless steel cradles are removable for direct dishwasher service
- Racks to accommodate food service needs for drying and storing
- We do not accept returns on any Dinex equipment or Dinex custom products. Please contact your local Dinex rep to ensure order accuracy prior to ordering.

Tech Specs

	US	Metric
Length	40.00 in	101.60 cm
Height	73.00 in	185.42 cm
Diameter	20.25 in	51.44 cm
Material	Stainless Steel	
Country of Origin	United States	
Freight Class	250	
Case Weight	151.00 lb	68.49 kg
Case Cube	34.22 ft3	0.97 m3
Case Length	40.00 in	101.60 cm
Case Width	20.25 in	51.44 cm
Case Height	73.00 in	185.42 cm
Pallet Case Qty	1	
Pallet Tier	1	
Pallet High	1	

Related Products

Product	Description	Case		
		Pack	Weight	Cube
DX1173XC10	Dinex® Drying Cradle Insert for 1173 Series 18" x 17.50" x 10.50"	1 cs	3.50 lb	1.91 ft³



DXIDPH3E1012 - Plate Dispensers Enclosed Style- 3 Silo 10-1/8" Plate - Stainless Steel

Details

Item #	Case Pack
DXIDPH3E1012	1 ea
Product #	Case UPC
DXIDPH3E1012	753806762770
Color	
Stainless Steel	



Invoice Description

PLATE HTR/ENCL 10-1/8"/3 SILO



Features

- Approximate capacities are 150 Plates / 108 Bowls
- Enclosed 3 silo- heated
- Stainless steel exterior shield
- Equipped with 4" heavy duty non-marking swivel casters
- Features the Dinex Spring-Pak™ self-leveling mechanism
- We do not accept returns on any Dinex equipment or Dinex custom products. Please contact your local Dinex rep to ensure order accuracy prior to ordering.

Tech Specs

	US	Metric
Length	46.50 in	118.11 cm
Height	36.75 in	93.34 cm
Depth	18.50 in	46.99 cm
Material	Stainless Steel	
Country of Origin	United States	
Harmonized Code	841981.9040	
Freight Class	100	
Case Weight	225.00 lb	102.06 kg
Case Cube	17.96 ft3	0.51 m3
Case Length	45.12 in	114.60 cm
Case Width	17.25 in	43.81 cm
Case Height	39.87 in	101.27 cm
Pallet Case Qty	1	
Pallet Tier	1	
Pallet High	1	

Related Literature

[103 Combination Heated Base & Plate Dispenser - 1 MB \(PDF\)](#)

OPEN STYLE TRAY DISPENSERS



DXIDT1S1520

Item Numbers

Single

- DXIDT1S1418
- DXIDT1S1520
- DXIDT1S1622

Double

- DXIDT2S1222
- DXIDT2S1418
- DXIDT2S1520
- DXIDT2S1622

Application

These self-leveling mobile tray dispensers are offered in two styles:

- Single stack, tubular frame with solid bottom.
- Double stack, tubular frame with solid bottom.

These self-leveling mobile tray dispensers can be found in tray lines, in the front or back-of-the house, or any place your needs require.

Construction

The lifting mechanism is constructed of stainless steel with all exposed parts having a No. 3 finish.

The Mobile Tray Dispenser is equipped with rollers and a full complement of stainless steel extension springs which can be easily disconnected to adjust the lifting rate.

A removable stainless steel carrier tray provides bottom support for trays being dispensed.

The base is fabricated from stainless steel and reinforced with stainless steel angles.

The square tube frames are fabricated from stainless steel and securely welded to stainless steel angles on underside of base.

The tubular frames are reinforced by stainless steel square tubes welded to each vertical frame.

Four 5" heavy-duty non-marking swivel casters (2 with brakes) are securely mounted to the base and a non-marking bumper is attached at each corner.

Standard Features

- Stainless steel construction including extension springs for long lasting dependable service.
- Self-leveling mechanism lifts out for easy cleaning.
- Field adjustable to accommodate different weights.
- Corner Bumpers.

Warranty

One years parts and labor.

OPEN STYLE TRAY DISPENSERS

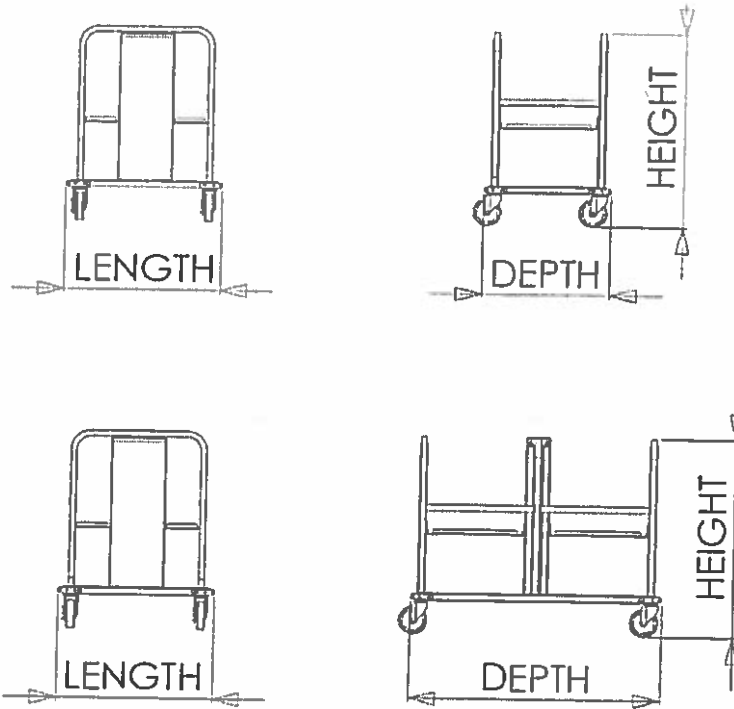

Items and Dimensions

ITEM NUMBER	MODEL NUMBER	LENGTH	DEPTH	HEIGHT	CASTERS		MAX TRAY SIZE	SHIP WEIGHT	SHIP CUBE
					TYPE	DIA.			
DXIDT1S1418	IDT1S/1418	27.45" (69.7 cm)	22.7" (57.7 cm)	36" (91.4 cm)	4 Swivel 2 w/brake	5"	14.375" x 18.75" (36.5 cm x 47.6 cm)	133 lb (60.3 kg)	12.98
DXIDT1S1520	IDT1S/1520	27.45" (69.7 cm)	22.7" (57.7 cm)	36" (91.4 cm)	4 Swivel 2 w/brake	5"	15.375" x 20.75" (39.1 cm x 52.7 cm)	133 lb (60.3 kg)	12.98
DXIDT1S1622	IDT1S/1622	27.45" (69.7 cm)	22.7" (57.7 cm)	36" (91.4 cm)	4 Swivel 2 w/brake	5"	16.375" x 22.75" (41.6 cm x 57.8 cm)	138 lb (62.6 kg)	12.98
DXIDT2S1222	IDT2S/1222	27.45" (69.7 cm)	22.7" (57.7 cm)	36" (91.4 cm)	4 Swivel 2 w/brake	5"	12.70" x 22.70" (32.3 cm x 57.7 cm)	156 lb (70.8 kg)	20.9
DXIDT2S1418	IDT2S/1418	22.7" (57.7 cm)	22.7" (57.7 cm)	36" (91.4 cm)	4 Swivel 2 w/brake	5"	14.375" x 18.75" (36.5 cm x 47.6 cm)	152 lb (68.9 kg)	25.5
DXIDT2S1520	IDT2S/1520	22.7" (57.7 cm)	22.7" (57.7 cm)	36" (91.4 cm)	4 Swivel 2 w/brake	5"	15.375" x 20.75" (39.1 cm x 52.7 cm)	170 lb (77.1 kg)	25.5
DXIDT2S1622	IDT2S/1622	22.7" (57.7 cm)	22.7" (57.7 cm)	36" (91.4 cm)	4 Swivel 2 w/brake	5"	16.375" x 22.75" (41.6 cm x 57.8 cm)	174 lb (78.9 kg)	25.5

DINEX. | CARLISLE
INNOVATION FOR HEALTHCARE FOODSERVICE

Please confirm that you have the most current specification sheet by visiting www.dinex.com.
Dinex® reserves the right to change specifications and product design without notice.
Such revisions do not entitle the buyer to corresponding changes, improvements, additions or replacements for previously purchased equipment.

Printed in USA

DINEX. | CARLISLE

4711 E. Hefner Road
Oklahoma City, OK 73131
800.654.8210 Fax: 405.475.5607
www.dinex.com

OpenTrayDispenser_SpecSheet

ATTACHMENT D



DXDVLHF3 - Valuexpress Hot Food Counter - 3 Well 49"L x 30"D x 36"H - Stainless Steel

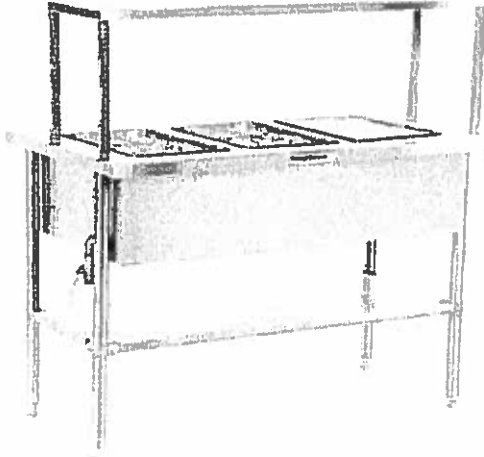

Details

Item #	Case Pack
DXDVLHF3	1 ea
Product #	Case UPC
DXDVLHF3	753806778078
Color	
Stainless Steel	

Invoice Description
VALUE LINE HOT FOOD CNTR, 3 W



Features

- Stainless steel protector guards
- Over-shelf and Under-shelf available
- Easy Access electrical service panel
- We do not accept returns on any Dinex equipment or Dinex custom products. Please contact your local Dinex rep to ensure order accuracy prior to ordering.
- The listed power is for the base unit. If options are added, contact customer service for the final power consumption and hardware configuration.
- NSF Listed
- Works with self-serve and server-style dining; one unit can be adjusted for both applications during different parts of the day
- Fully adjustable

Tech Specs

	US	Metric
Length	49.00 in	124.46 cm
Height	36.00 in	91.44 cm
Depth	30.00 in	76.20 cm
Material	Stainless Steel	
Country of Origin	United States	
Harmonized Code	841981.9040	
Freight Class	100	
Case Weight	190.00 lb	86.18 kg
Case Cube	30.62 ft3	0.87 m3
Case Length	49.00 in	124.46 cm
Case Width	30.00 in	76.20 cm
Case Height	36.00 in	91.44 cm
Pallet Case Qty	1	
Pallet Tier	1	
Pallet High	1	

Related Literature

- [450 Hot Food Counter - Value Line - 143 KB \(PDF\)](#)
- [451 ColdFoodCounters - 155 KB \(PDF\)](#)
- [452 SolidTop Urn Stand - 129 KB \(PDF\)](#)



DXTVL2T1D16 - TVL Economy Tray Cart 27.72" x 28.12" x 49.83" - Stainless Steel

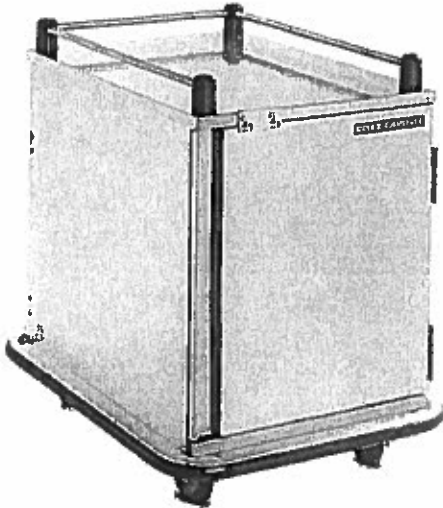

Details

Item #	Case Pack
DXTVL2T1D16	1 ea
Product #	Case UPC
DXTVL2T1D16	10753806031118
Color	
Stainless Steel	



Invoice Description
DXTVL2T1D16 CART



Features

- Single door tray delivery cart with an all stainless steel modular construction
- TVL Carts are designed to hold multiple tray sizes: 14" x 18", 15" x 20", 12" x 19", 12"x 20"
- Standard 5" tray height spacing
- Drop down latch for doors
- Perimeter bumper frame
- Bottom mounted floor drain
- Interchangeable rack system adjusts to accommodate different size trays
- Comes with 5" Performa casters with sealed stainless steel bearings (2 rigid, 2 swivel with side lock brakes)
- Optional Second Door
- NSF Listed
- We do not accept returns on any Dinex equipment or Dinex custom products. Please contact your local Dinex rep to ensure order accuracy prior to ordering.

Tech Specs

	US	Metric
Length	27.72 in	70.41 cm
Height	49.83 in	126.57 cm
Depth	38.12 in	96.82 cm
Material	Stainless Steel	
Country of Origin	United States	
Harmonized Code	841990.9520	
Freight Class	100	
Case Weight	201.00 lb	91.17 kg
Case Cube	31.60 ft3	0.89 m3
Case Length	28.00 in	71.12 cm
Case Width	39.00 in	99.06 cm
Case Height	50.00 in	127.00 cm
Pallet Case Qty	1	
Pallet Tier	1	
Pallet High	1	

Related Literature

[605 TVL EconomyCarts TVL2T1D - 259 KB \(PDF\)](#)

[Dinex New Prod 2013 - 2 MB \(PDF\)](#)

[TVL Cart Manual - 1 MB \(PDF\)](#)



DX9CP02 - Dinet® Entree Plate 9" (12/cs) - White

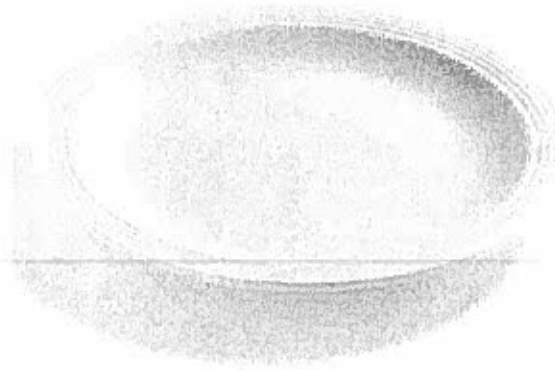

Details

Item #	Case Pack
DX9CP02	1 cs
Product #	Inner Pack Size
DX9CP	12 ea
Color	Case UPC
02 - White	753806220485



Invoice Description

9" CHINA ENTREE PLATE WHITE



Features

- Enhance your patient tray with Dinet China
- Pieces are elegantly embossed
- The perfect choice for room service systems
- Increases patient satisfaction
- We do not accept returns on any Dinex equipment or Dinex custom products. Please contact your local Dinex rep to ensure order accuracy prior to ordering.

Tech Specs

	US	Metric
Diameter	9.00 in	22.86 cm
Material	China	
Country of Origin	China	
Harmonized Code	392410.2000	
Freight Class	60	
Case Weight	17.00 lb	7.71 kg
Case Cube	0.52 ft ³	0.01 m ³
Case Length	10.00 in	25.40 cm
Case Width	9.00 in	22.86 cm
Case Height	10.00 in	25.40 cm
Pallet Case Qty	24	
Pallet Tier	24	
Pallet High	1	

Related Literature

[Dinex New Prod 2013 - 2 MB \(PDF\)](#)

Related Products

Product	Description	Pack Size	Case		
			Pack	Weight	Cube
DX4T9	Cite® Entree Plate 9" (24/cs)	24 ea	1 cs	20.80 lb	0.61 ft ³



DXSMC1418NSM03 - Glasteel™ Non-Skid Tray 14" x 18" - Black

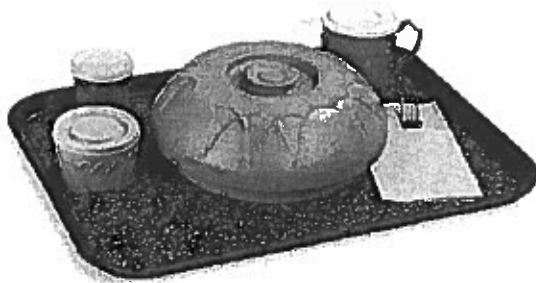

Details

Item #	Case Pack
DXSMC1418NSM03	1 cs
Product #	Case UPC
DXSMC1418NSM	10753806033631
Color	
03 - Black	

Invoice Description

TRAY 14X18 NON-SKID SMC MARBLE BLACK
12/CS



Features

- Best performance non-skid tray on the market; super grip surface
- Holds even the heaviest items in place with minimal sliding even if the tray gets wet
- Non-skid surface printed with exclusive non-fading inks
- Molded-in, non-skid surface stays bonded to the tray and continues to perform even after years of washing
- Stain, scratch and odor resistant
- Sturdy fiberglass construction with reinforced edges to resist chipping
- Fits standard equipment
- Dishwasher safe and easy to clean; use non-metal brush for scrubbing
- 2 year warranty
- NSF Listed

Available Colors

Item	Swatch	Color
<u>DXSMC1418NSM03</u>		Black
<u>DXSMC1418NSM23</u>		Gray
<u>DXSMC1418NSM31</u>		Latte

Tech Specs

	US	Metric
Length	18.00 in	45.72 cm
Width	14.00 in	35.56 cm
Depth	0.75 in	1.91 cm
Material	SMC	
Country of Origin	Mexico	
Harmonized Code	392410.3000	
Freight Class	65	
Case Weight	25.00 lb	11.34 kg
Case Cube	0.92 ft3	0.03 m3
Case Length	19.75 in	50.16 cm
Case Width	15.30 in	38.86 cm
Case Height	5.25 in	13.34 cm
Pallet Case Qty	54	
Pallet Tier	6	
Pallet High	9	



DX821084 - Base for STSII & Turbo-Temp Induction Chargers (12/cs) - Sage

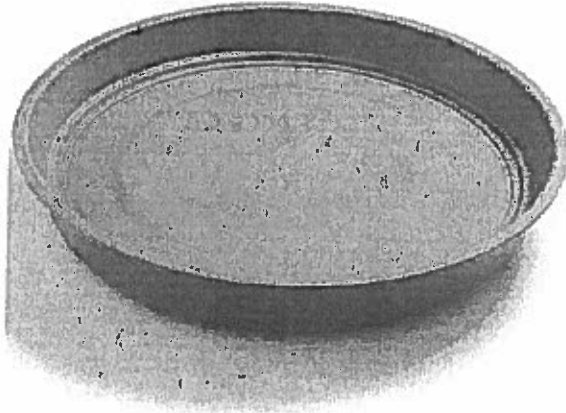

Details

Item #	Case Pack
DX821084	1 cs
Product #	Inner Pack Size
DX8210	12 ea
Color	Case UPC
84 - Sage	10753806008745



Invoice Description

SMART THERM BASE SAGE, 12/CS



Features

- Built-in chip that relays information to the heating unit
- Made from high temperature rugged plastic
- Seamless with no holes to intake water
- Contains internal phase change material similar to a wax base
- Allows lower energy input to hold longer
- We do not accept returns on any Dinex equipment or Dinex custom products. Please contact your local Dinex rep to ensure order accuracy prior to ordering.

Available Colors

Item	Swatch	Color
DX821003		Onyx
DX821008		Hunter Green
DX821031		Latte
DX821050		Dark Blue
DX821061		Cranberry
DX821068		Napoli Plum
DX821084		Sage

Tech Specs

	US	Metric
Height	1.63 in	4.14 cm
Diameter	9.75 in	24.77 cm
Material	Plastic	
Country of Origin	United States	
Harmonized Code	392410.4000	
Freight Class	65	
Case Weight	18.40 lb	8.35 kg
Case Cube	0.79 ft3	0.02 m3
Case Length	12.00 in	30.48 cm
Case Width	12.00 in	30.48 cm
Case Height	9.50 in	24.13 cm
Pallet Case Qty	36	
Pallet Tier	9	
Pallet High	4	

Related Literature

[149RS SmartTherm STSII Induction Charger SpecSheet](#) - 236 KB (PDF)

[149 STSII DX811220 SpecSheet](#) - 293 KB (PDF)

[Dinex New Prod 2013](#) - 2 MB (PDF)



DX107784 - Insul-Base for Insulated Domes 9-1/2" D (12/cs) - Sage

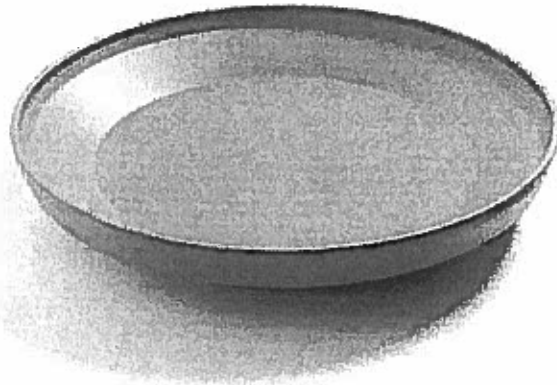

Details

Item #	Case Pack
DX107784	1 cs
Product #	Inner Pack Size
DX1077	12 ea
Color	Case UPC
84 - Sage	753806191617



Invoice Description
INSUL-BASE SAGE



Features

- Insulated base to hold standard 9" plates
- Fits all Dinex Entrée Domes
- Double-wall insulated with ozone-safe, urethane foam
- We do not accept returns on any Dinex equipment or Dinex custom products. Please contact your local Dinex rep to ensure order accuracy prior to ordering.

Available Colors

Item	Swatch	Color
DX107703		Onyx
DX107708		Forest Green
DX107715		Teal
DX107731		Latte
DX107750		Dark Blue
DX107756		Mauve
DX107761		Cranberry
DX107768		Plum
DX107784		Sage

Tech Specs

	US	Metric
Height	1.88 in	4.76 cm
Diameter	9.50 in	24.13 cm
Material	Urethane Foam	
Country of Origin	United States	
Case Weight	6.40 lb	2.90 kg
Case Cube	0.56 ft3	0.02 m3
Case Length	10.00 in	25.40 cm
Case Width	9.75 in	24.77 cm
Case Height	10.00 in	25.40 cm
Pallet Case Qty	96	
Pallet Tier	16	
Pallet High	6	

Copyright © 2015 Carlisle FoodService Products. All rights reserved.



DX540084 - Fenwick Insulated Dome 10" D (12/cs) - Sage



Details

Item #	List Price
DX540084	\$369.80 cs
Product #	Case Pack
DX5400	1 cs
Color	Inner Pack Size
84 - Sage	12 ea
	Case UPC
	10753806011981





Invoice Description
FENWICK DOME SAGE



Features

- Modern insulated dome for 9" plate service features molded-in handle and high food clearance
- Double-wall insulated with ozone-safe, urethane foam
- For hot or cold foods and beverages
- Not recommended for microwave
- We do not accept returns on any Dinex equipment or Dinex custom products. Please contact your local Dinex rep to ensure order accuracy prior to ordering.

Available Colors

Item	Swatch	Color
DX540003		Onyx
DX540031		Latte
DX540050		Midnight Blue
DX540061		Cranberry
DX540084		Sage

Related Literature

- [Clear Dome, Cool Base Temp Chart PDF](#) - 1 MB (PDF)
- [Dinex Drinkware Brochure](#) - 1 MB (PDF)
- [Dinex Insulated Ware Flyer - NO PRICING](#) - 354 KB (PDF)
- [Disposable Lid Cross Reference](#) - 32 KB (XLSX)

Tech Specs

	US	Metric
Height	2.88 in	7.30 cm
Diameter	10.00 in	25.40 cm
Material	Urethane Foam	
Country of Origin	United States	
Harmonized Code	392350.0000	
Case Weight	10.00 lb	4.54 kg
Case Cube	0.93 ft3	0.03 m3
Case Length	14.25 in	36.20 cm
Case Width	10.50 in	26.67 cm
Case Height	10.75 in	27.30 cm
Pallet Case Qty	24	
Pallet Tier	6	
Pallet High	4	

Related Products

Product Description	Pack Size	Case			List Price ¹
		Pack	Weight	Cube	
Related Products					

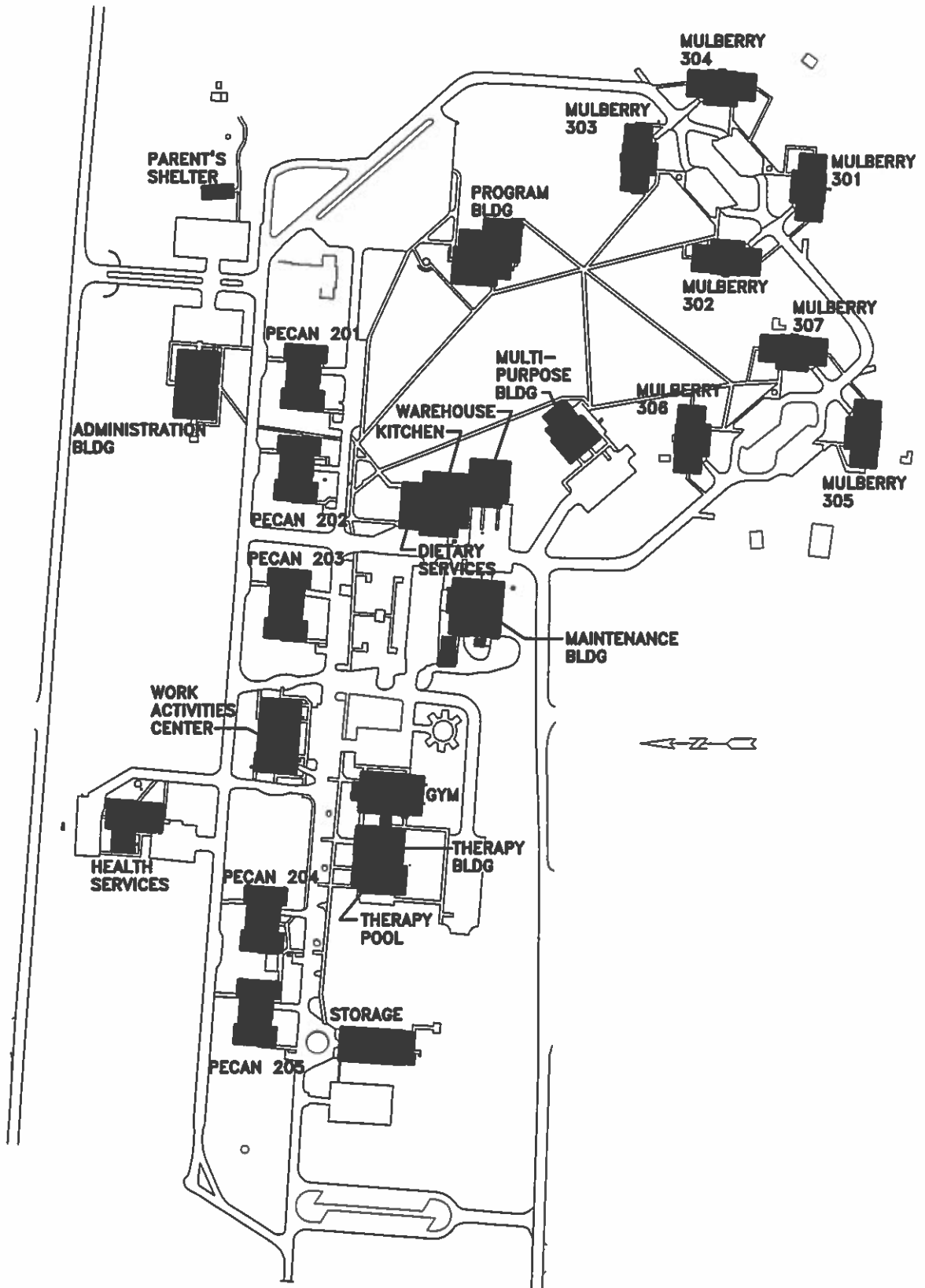

PEE DEE CENTER CAMPUS

714 NATIONAL CEMETERY RD.
 FLORENCE, SC 29506

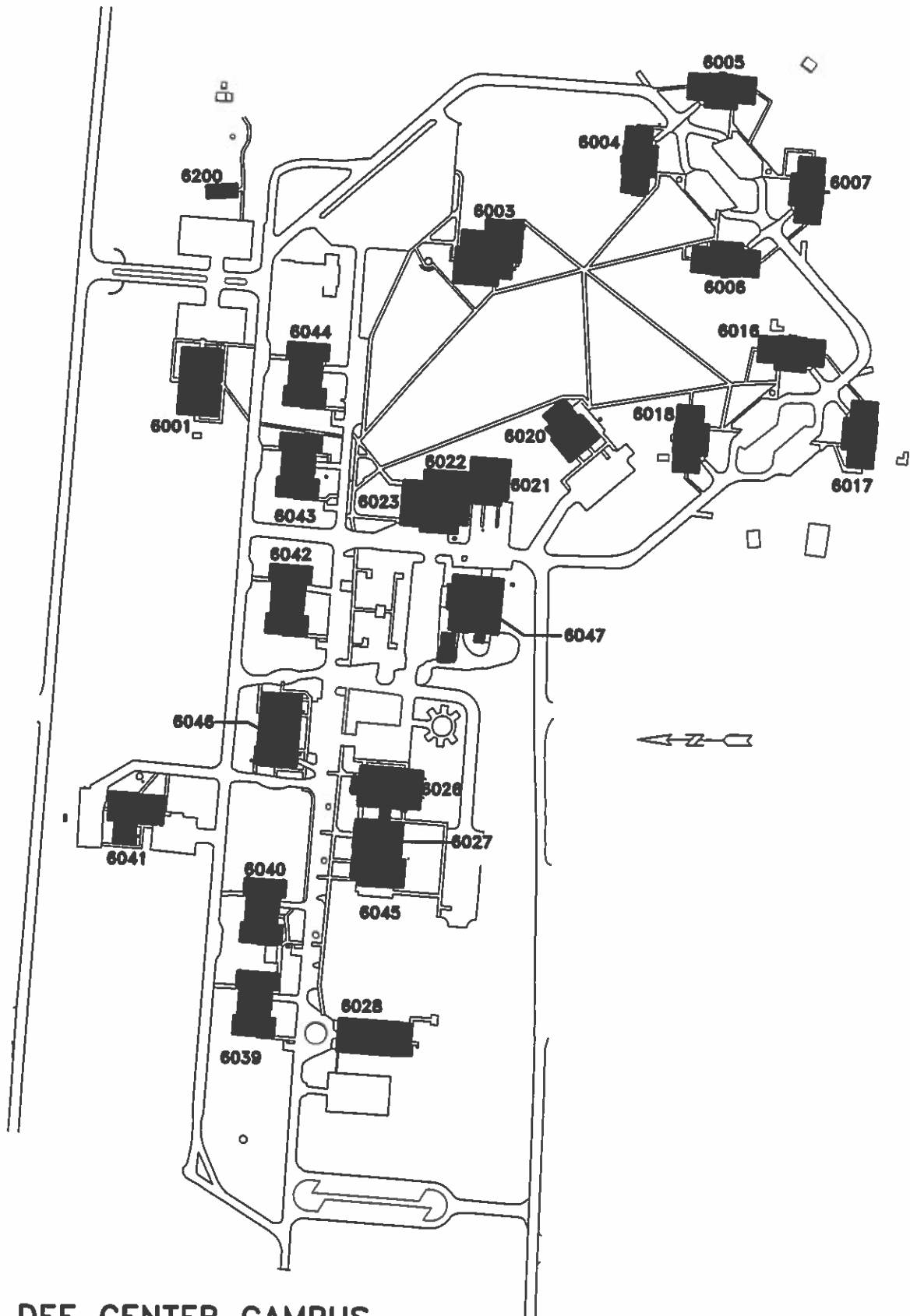

PEE DEE CENTER CAMPUS
714 NATIONAL CEMETERY RD.
FLORENCE, SC 29506

PEE DEE CENTER BUILDING LEGEND

NO.	BUILDING NAME
6001	ADMINISTRATION
6003	PROGRAM BUILDING
6004	303 MULBERRY
6005	304 MULBERRY
6006	302 MULBERRY
6007	301 MULBERRY
6016	307 MULBERRY
6017	305 MULBERRY
6018	306 MULBERRY
6020	MULTI-PURPOSE BUILDING
6021	WAREHOUSE
6022	KITCHEN
6023	CAFETERIA (DIETARY SERVICES)
6026	GYMNASIUM
6027	THERAPY BUILDING
6028	STORAGE
6039	205 PECAN DRIVE (DORM E)
6040	204 PECAN DRIVE (DORM D)
6041	MEDICAL SERVICES
6042	203 PECAN DRIVE (DORM C)
6043	202 PECAN DRIVE (DORM B)
6044	201 PECAN DRIVE (DORM A)
6045	THERAPY POOL
6046	WORK ACTIVITIES BUILDING
6047	MAINTENANCE BUILDING
6200	PARENTS SHELTER